

**AVON**  
PROTECTION



# **EXOSKIN<sup>®</sup>-S2**

ENHANCED PROTECTION CBRN SUIT

USER INSTRUCTIONS



# CONTENTS

Table of Contents	3
Abbreviations & Acronyms	4
1.0 Warnings, Cautions & Notes	5
2.0 EXOSKIN-S2 Technical Overview	7
3.0 Donning the EXOSKIN-S2	10
4.0 Doffing a Non-Contaminated EXOSKIN-S2	20
5.0 Doffing a Contaminated EXOSKIN-S2	20
6.0 Folding the EXOSKIN-S2 Jacket	21
7.0 Life Cycle of the EXOSKIN-S2	23
8.0 Warnings & Cautions Under Normal Operating Conditions	26
9.0 Cleaning Instructions	27
10.0 System Options & Configurations	29
11.0 Identification & Labeling	30
12.0 Storage	32
13.0 Packaging	32
14.0 Shelf-Life	33
15.0 Additional Information	34
16.0 Checklist	34

## ABBREVIATIONS & ACRONYMS

AEP	Allied Engineering Project
BBP	Blood Borne Pathogens
CBRN	Chemical, Biological, Radiological & Nuclear
CCA	Contamination Control Area
CE	Conformité Européene (European Conformity)
CWA	Chemical Warfare Agent
C50	Avon Protection Respirator
EU	European Union
EXOSKIN-S2	Equipment covered in this UI
FM50, FM53, FM54	Avon Protection Respirators
GSR	Avon Protection General Service Respirator
ISO 9001	International Organization for Standardization
Mustard Gas	Blister Agent
NATO	North Atlantic Treaty Organization
PPE	Personal Protective Equipment
POL	Petrol, Oils, Lubricants
Sarin	Nerve Agent
Soman	Nerve Agent
SOP(s)	Standard Operating Procedure(s)
UV	Ultra Violet
User Instruction (UI)	This Document
VX	Venomous (Agent) X Nerve Agent

# 1.0 WARNINGS, CAUTIONS & NOTES

---

## IMPORTANT INFORMATION

- The EXOSKIN-S2 is intended to protect the user from chemical warfare agent (CWA) airborne vapor and life-threatening contaminated environments.
  - It is a life-saving product and should be treated as a special item of personal protective equipment (PPE) that is well cared for and maintained according to the instructions in this User Instruction (UI).
  - Mis-use may seriously degrade the performance of this PPE.
  - Follow the instructions on donning, doffing, and laundering.
  - Be aware of the importance in maintaining its structural integrity.
  - Damage inflicted on the suit may inhibit its ability to protect the user.
- 

## SYMBOL OVERVIEW



This symbol is used to give a warning that is related to the safe use of the garment. Follow the instructions to avoid death or serious injury to personnel or damage to the product.



This symbol is used to give a caution that is related to the safe use of the garment. Follow the instructions to avoid injury to personnel or damage to the product.

**NOTE:**

This symbol indicates notes that should be read to maximize the efficiency and safe use of the garment.

---

## INFORMATION OVERVIEW

This UI is unique to the usage of the EXOSKIN-S2 CBRN suit.



The user must read this UI and all warning and danger labels and be trained in the use of this garment before wearing.



Never wear the EXOSKIN-S2 in a contaminated environment without the approved respirator, canister, footwear and gloves. This garment only provides qualified protection against chemical, biological and radiological hazards.



Wear this garment only in vapor/gas/particulate/limited splash protection CBRN environments where Class C permeable systems are appropriate.



This EXOSKIN-S2 provides limited protection against flame.



This EXOSKIN-S2 provides limited protection against abrasion, puncture, blood borne pathogens (BBP), other liquids, and gases.



This Class C permeable protection system has been certified to protect against agents identified in the NATO AEP38 process. This garment has not been certified for any other chemicals or hazardous materials.

## 2.0 EXOSKIN-S2 TECHNICAL OVERVIEW

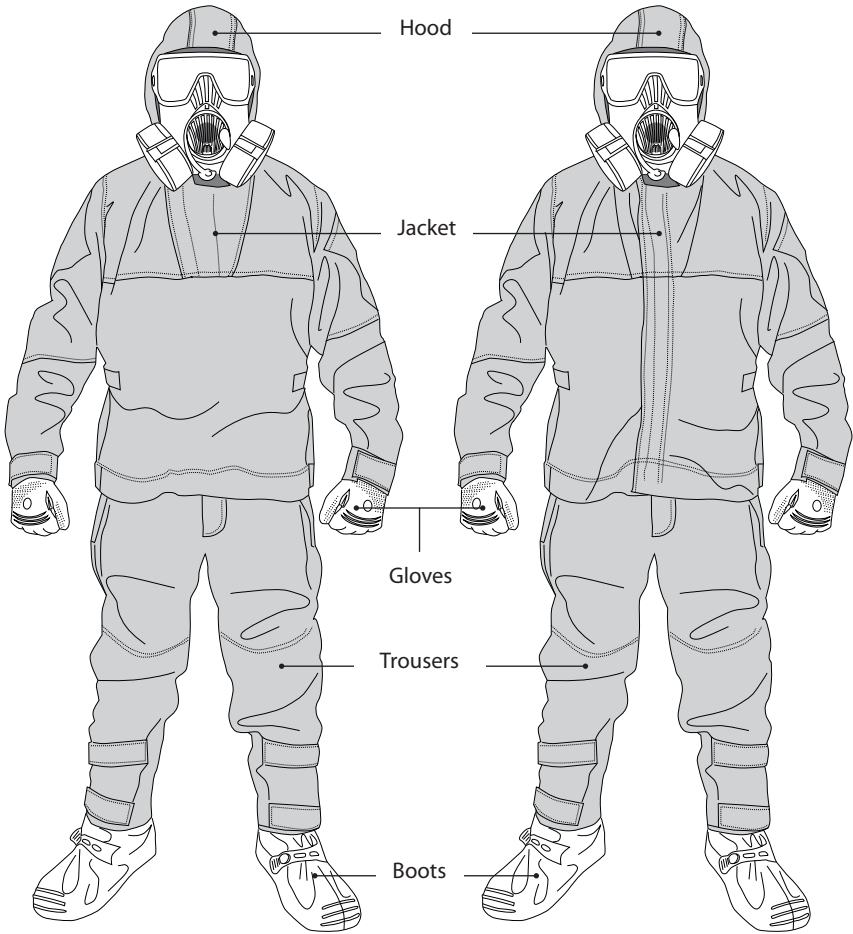

**EXOSKIN-S2**  
with '1/4 zipper' jacket

**EXOSKIN-S2**  
with 'full zipper' jacket

---

## EXOSKIN-S2 TECHNICAL OVERVIEW (CONTINUED)

The Avon Protection EXOSKIN-S2 is a Class C, permeable garment system within the CBRN categories defined by the North Atlantic Treaty Organization (NATO) and which is primarily intended for emergency donning at the onset of an airborne or environmentally hazardous chemical incident and worn in conjunction with approved respiratory, hand and foot protective equipment. It can be additionally worn in a standby state.

Users should be aware of the time exposure that the suit is designed for, i.e., once removed from the garment pouches, the suit has a functional life of 40 days in an uncontaminated condition. The end-user is tasked with accurately recording the exposure time to ensure that the suit is within its intended life cycle for future usage.

Permeable protection provided by the system is designed to primarily provide emergency usage against spontaneous attack/exposure.

The EXOSKIN-S2, can be worn as an over-garment, e.g. over a uniform, or as a stand alone suit worn over a base layer or underwear.

The EXOSKIN-S2 is a vapor barrier system that protects against multiple airborne chemical warfare, biological and qualified radiological\* agents in vapor and particulate form and provides 24-hour continuous protection when used in accordance with this UI.

The EXOSKIN-S2 is designed as a low physiological burden garment with reduced weight and heightened air permeability to diminish the user's operational fatigue and functional degradation. The EXOSKIN-S2 is compatible for use with most ballistic protection and load carriage webbing to be worn over the suit.

Uncontaminated suits may be laundered according to instruction up to 10 times without loss of functionality or degradation of protection.

Contaminated suits should not be reused or subjected to any proprietary decontamination processes such as autoclaving or foam detergent applications and should be disposed of according to user organizations Standard Operating Procedures (SOPs) and waste disposal regulations.

Conduct immediate decontamination SOPs to remove excess contaminant matter from the surface of the suit.

This should be followed by a regulated safe-undressing procedure after which suit replacement can be undertaken.

In all circumstances there should be no possibility of re-issue of a previously contaminated suit to any personnel (suit must be rendered unusable).

**NOTE:** \*Qualified radiological protection means protection against alpha and beta particulates; the suit offers no protection against gamma, neutron, or x-ray particulates.

---

## EXOSKIN-S2 TECHNICAL OVERVIEW (CONTINUED)

- The EXOSKIN-S2 is designed to address the requirements of European Conformity CE markings as set out in Regulation (EU) 2016/425.
- The EXOSKIN-S2 suit is designed to offer 24 hours cumulative protection in a contaminated environment.
- The user should be aware of the importance of the recommendations indicated below in terms of assuring personal safety and in complying with the scope of the Avon Protection CBRN warranty.
- The EXOSKIN-S2 suit is issued as a multi-pack of two garment pouches, one for the jacket and one for the trouser. These are both within a clear plastic outer bag that has a re-usable grip-seal.



The EXOSKIN-S2 has been designed to provide emergency protection against airborne chemical, biological agents and qualified radiological\* particulates (includes vapor threats). Its flame-retardant capability is provided by a surface application finish to the outer shell of the garment which is intended to protect against short burst flame and super-heated vapor. It should be noted that this is not protection against sustained flame contact. An additional fluorocarbon finish to the outer shell adds a durable water repellent and enhances resistance to Petroleum, Oil, Lubricants (POL) contaminants.

The inner liner of the EXOSKIN-S2 is an activated carbon material composite and provides the absorption functionality of the EXOSKIN-S2; it is this layer that is time-limited by exposure to the atmosphere - 40 days of non-contamination and 24 hours of continuous contamination. A further Care & Maintenance section follows this introduction in Section 9.0.

The EXOSKIN-S2 suit is manufactured in ISO 9001:2015 accredited facilities and is subject to Avon Protection CBRN comprehensive quality management system, also accredited within the ISO 9001:2015 framework that assures its fitness for purpose.

It is, nonetheless, an important element of any PPE usage protocol that the individual wearer shall be responsible for the maintenance and upkeep of equipment and where concerns are raised the product must be replaced under local SOPs.

### 3.0 DONNING THE EXOSKIN-S2

The descriptions and donning/doffing sequences within this UI are based upon the manufacturer's prior experience of supplying equivalent type CBRN garments to public sector organizations and its understanding of CBRN environments.

The donning descriptions and sequences shown indicate a recommended emergency donning procedure in the face of an active CBRN event.

The descriptions are recommendations. Local SOPs may vary from these and due consideration should be given to appropriate precedence in operational environments. In this context, the manufacturers recommendations are subordinate to end-user SOP's.

The buddy system referred in the donning/ doffing paragraphs following are used to confirm that the EXOSKIN-S2 has been fitted correctly and that it is secured and sealed in accordance with the steps provided. Conversely, that it is safely and effectively removed to limit the possibility of cross-contamination.



At the onset of an emergency donning, the respirator must be the first item of protection fitted with the appropriate canister for the threat.

'Shake-out' the trouser into shape and fully open the fly zip. During the donning process all care must be taken not to damage the garment.



Don the trousers first

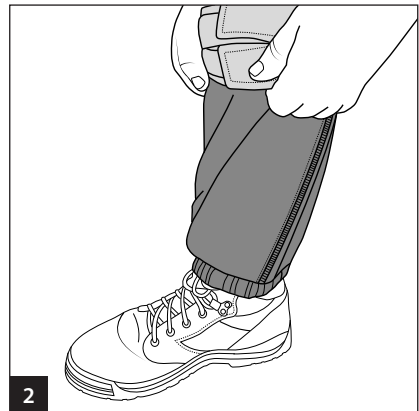

Take care when inserting a booted foot to ensure the carbon liner material is not damaged

## DONNING THE EXOSKIN-S2 (CONTINUED)

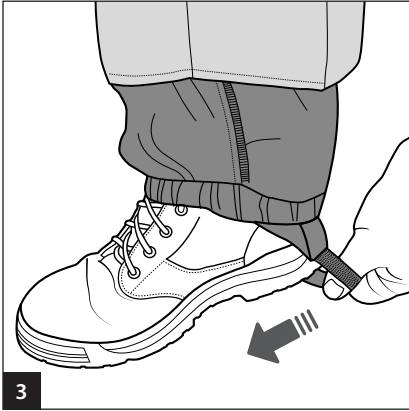

With care, pull carbon liner inner leg over combat boot shank and pull stirrup over the heel of the boot

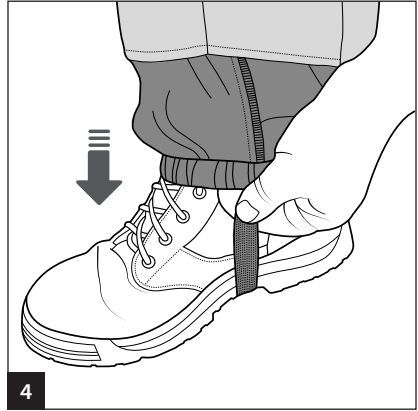

Pull stirrup under the boot heel from the rear and ensure gaiter covers the ankle area

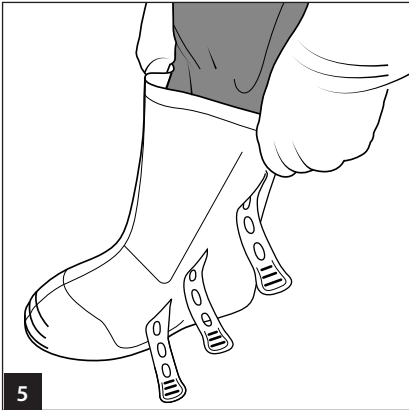

Don EXOSKIN-B1 overboots

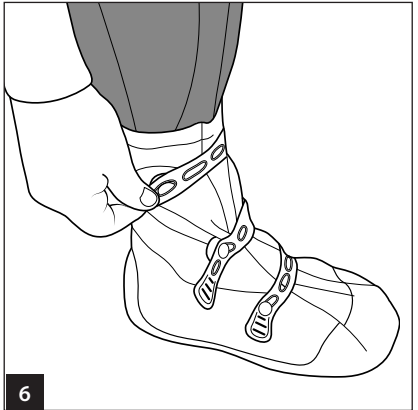

Firmly secure thong fastenings starting at the lower end and working up to the top of the boot shank. Wrap excess material inward before securing the straps

## DONNING THE EXOSKIN-S2 (CONTINUED)

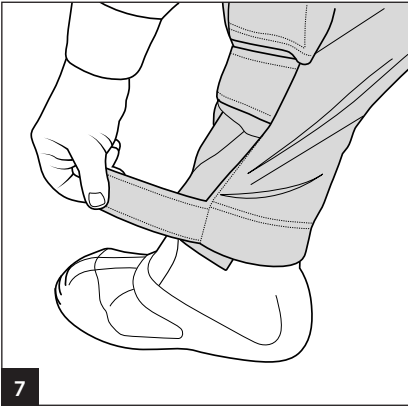

Roll outer trouser down over the shank of the EXOSKIN-B1 overboot and secure the hook & loop straps firmly

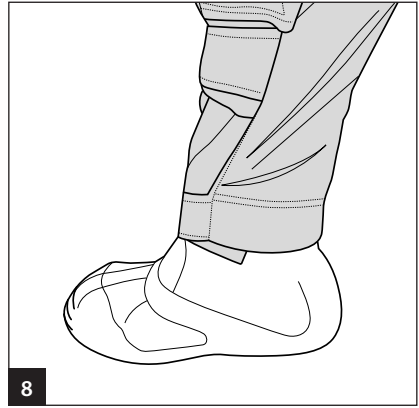

Ensure excess material is folded inward within the straps

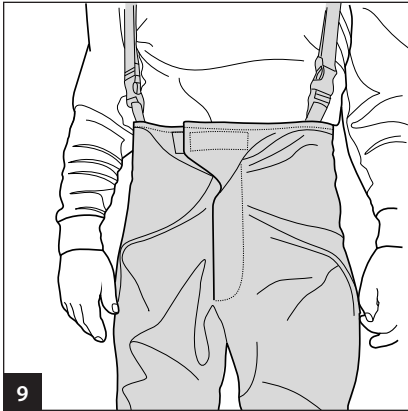

Fasten zip fly and close hook & loop waist fastening

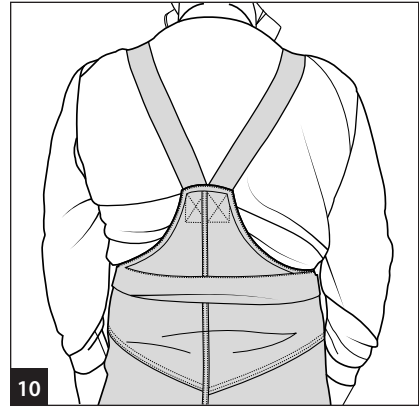

Pass braces from back to front and secure using front buckle side release fastening

## DONNING THE EXOSKIN-S2 (CONTINUED)

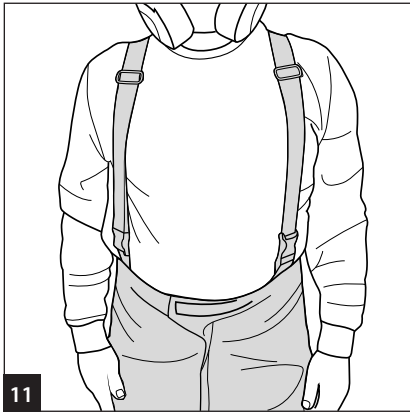

Adjust the length of the braces to hold trousers securely but not to hinder movement or cause discomfort. Any excess strap material should be taken up by the buckles

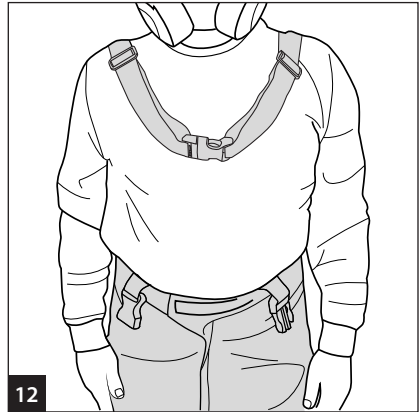

If required for urination/defecation drills IAW local procedures, unfasten braces from trouser connectors and snap together to prevent trousers slipping and loss of the braces snap connectors

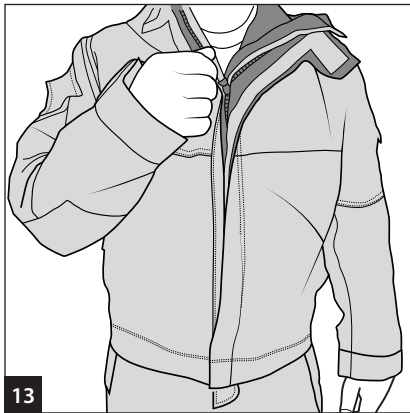

### Full Zip Jacket:

Shake out jacket, unzip the frontal closure and don. Close front zip to the position of trouser waistband ensuring the zip connector pins at the lower edges are inserted cleanly and fully into the slider assembly to allow clean zip movement and avoid jamming

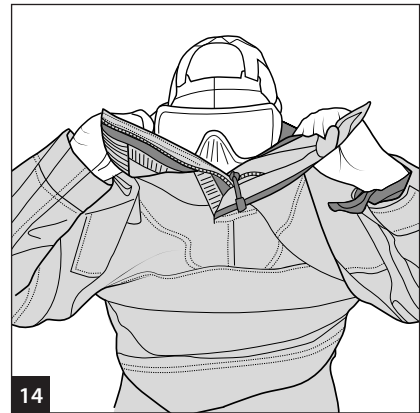

### Quarter Zip Jacket:

Shake out jacket, unzip the front closure and don taking extreme care not to dislodge the respirator by sliding the jacket over the respirator and canister

## DONNING THE EXOSKIN-S2 (CONTINUED)



### Full Zip Jacket:

Pull the jackets outer waist girth elasticated hook & loop strap to grip the waist and secure

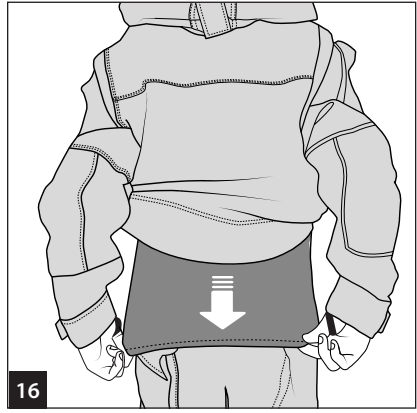

### Full Zip Jacket:

Ensure inner carbon liner is pulled fully down at the rear of the jacket to cover the waist portion of the trousers

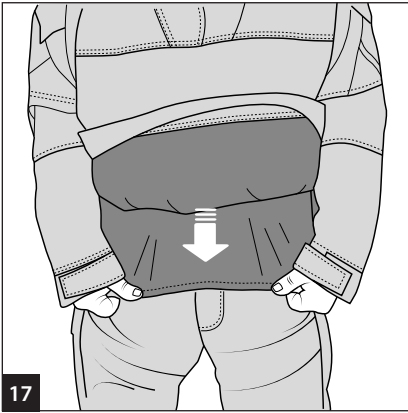

### Quarter Zip Jacket:

Pull the jackets inner waist skirt down until it covers the top of the trouser. Pull the outer jacket down to cover the inner skirt

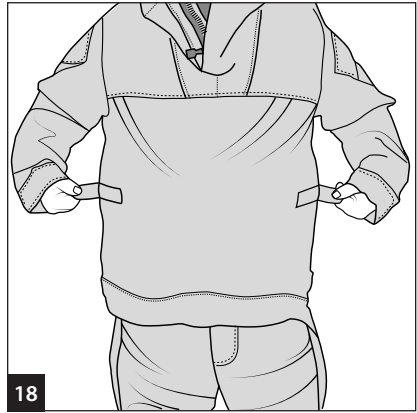

### Quarter Zip Jacket:

Adjust the hook & loop fasteners at the waist and secure

## DONNING THE EXOSKIN-S2 (CONTINUED)



Pull the jacket hem hook & loop tabs firmly to a position that allows free leg movement but closes excess material around the lower jacket and secure

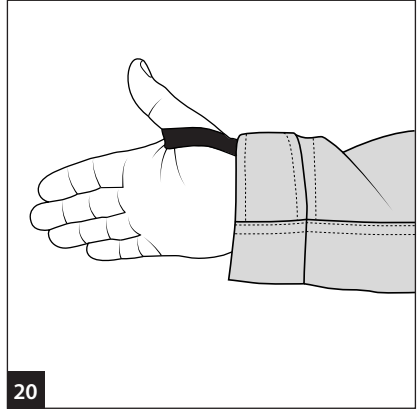

Donning hand protection  
Hook sleeve elastic loop over thumb to prevent inner liner movement

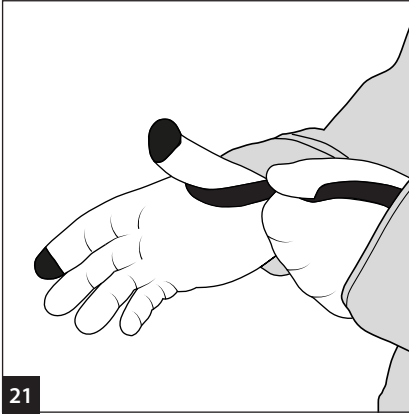

Don the cotton liner glove then follow with the EXOSKIN-G1 glove

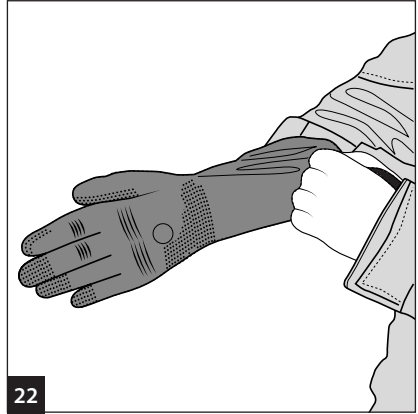

Pull the shank of the glove to its full extent up the arm

## DONNING THE EXOSKIN-S2 (CONTINUED)

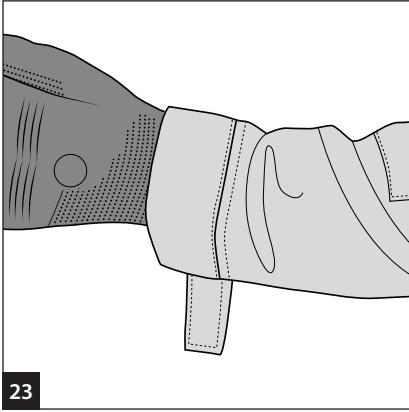

Ensure the jacket sleeve is loose enough to pull down over the glove shank

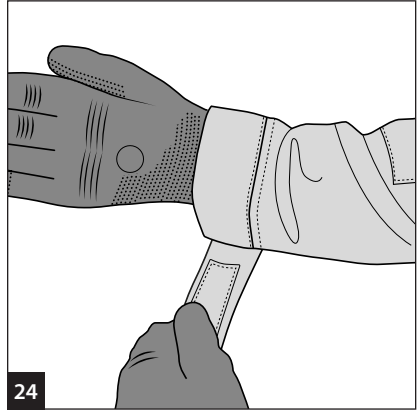

Pull the jacket sleeves fully down over the glove shank to wrist level. Gather the jacket sleeve hem area into a double fold and secure the hook & loop adjustment fasteners across the closure

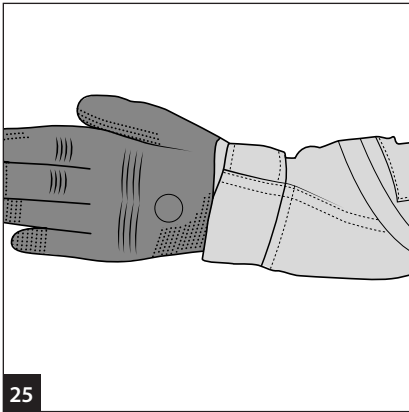

Make the closure as tight as possible without hindering arm and hand movement functionality

Repeat this process for both gloves ensuring that there is a clean material fold and secure fastening across both wrists



Pull the hood carefully down over the respirator as far over the front of the face piece as is possible ensuring there is no snagging or dislodgement of the respirator fit

## DONNING THE EXOSKIN-S2 (CONTINUED)

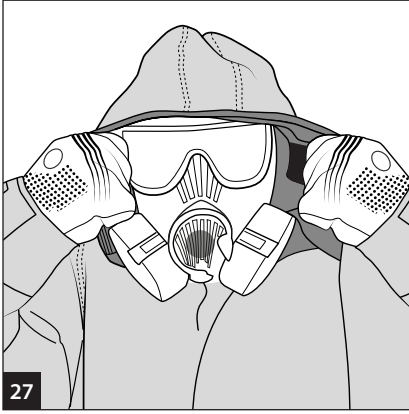

Ensure the jacket hood temple pads are facing towards the back of the head

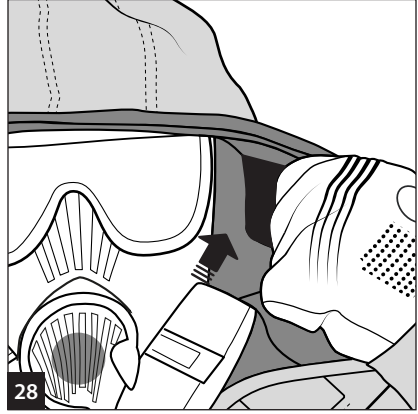

Ensure the jacket hood temple pads are situated comfortably on the temple area either side of the head

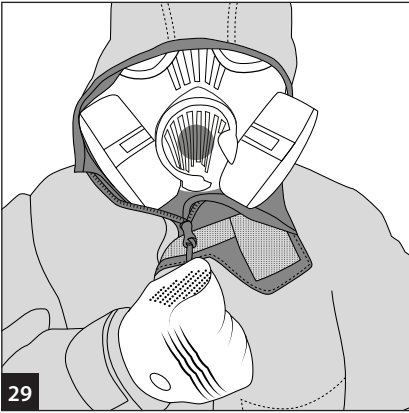

With the hood pulled as far down over the respirator facepiece as possible draw the jacket front zip up towards the throat

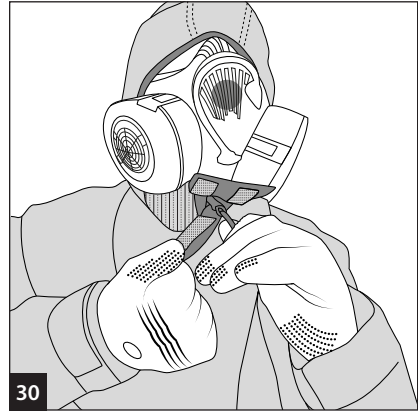

The wearer should tilt their head backward and pull the jacket front zip fully up to its closed position

**NOTE:** If available Use "Buddy System" for steps 27-34.

## DONNING THE EXOSKIN-S2 (CONTINUED)

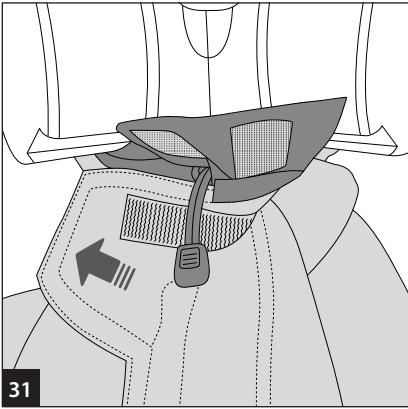

The hook & loop horizontal throat tab, situated on the left as worn, should be drawn across the throat area, overlapping the carbon liner tab and secured

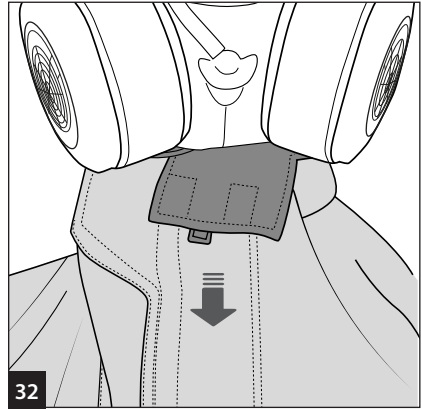

Attention should be paid to ensuring the lower section of the jackets hood rim, once the zip is closed, is located over the throat flange/lip of the respirator

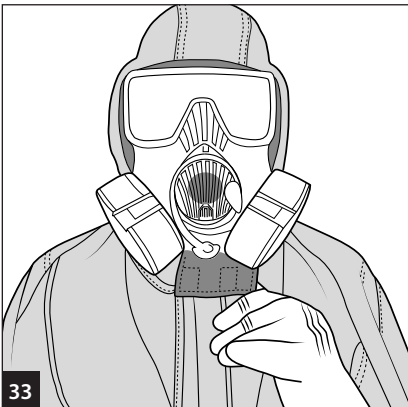

The wearer should ensure the zip pull tag is folded over the top of the hook and loop horizontal throat tab and is secured in place by the additional hook and loop vertical throat tab

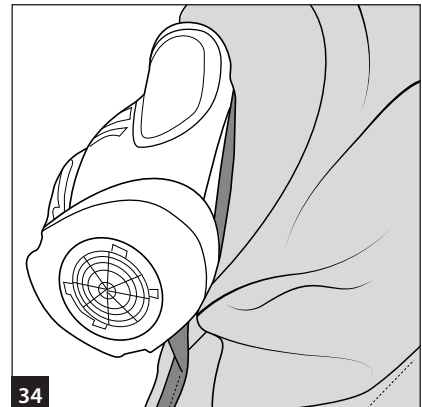

Draw the outer elasticated edges of the hood around the respirators face piece structure, using the flanged ridges around the lens to secure a close fit between hood elastic and face piece

## DONNING THE EXOSKIN-S2 (CONTINUED)

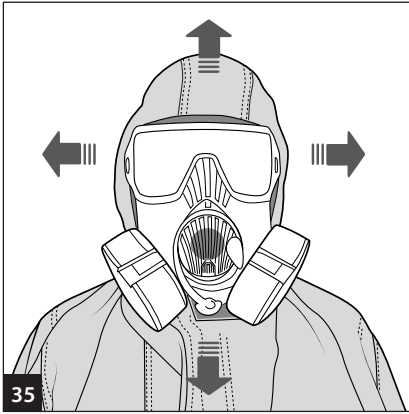

The wearer should test for freedom of head movement and adjust this tab as necessary but ensuring that there is no dislodging of the material/respirator interfaces. It is critically important to ensure a secure and operable closure at this point

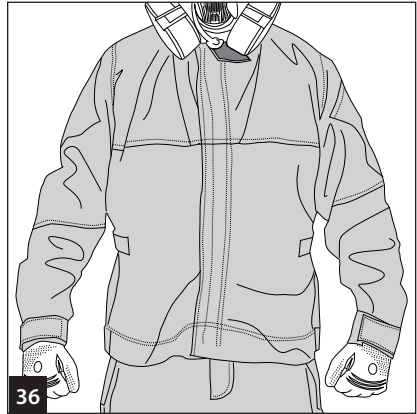

The front flap should now be fastened ensuring hook & loop tape is fully secured across the jacket's frontal zip and fully engaged down its length

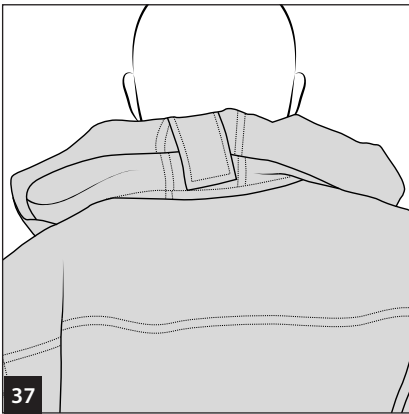

**Standby Mode:** The Hood of the suit can be rolled internally, outer material showing and secured with the hook & loop tab situated on the inside centre line of the suit

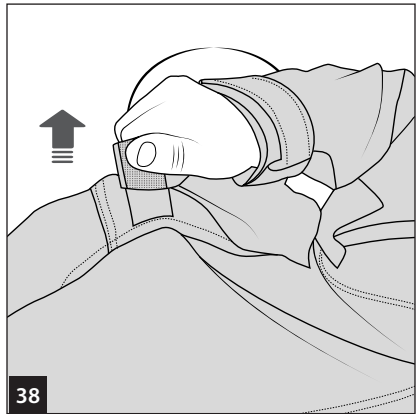

To transit from standby mode, don respirator immediately if required, pull the hook and loop tab directly upward and tuck inside the jacket. The hood can then be unrolled and donning commenced from this point. (Slides 26 - 36)

## 4.0 DOFFING A NON-CONTAMINATED EXOSKIN-S2

When doffing a non-contaminated suit, the user should refer to their local CCA protocols. However, a general recommendation follows:

- When opening hook & loop fasteners, care should be exercised to ensure that tabs are pulled open in the same direction of the fastening position, i.e., do not pull tabs open at a diagonal or counter grain direction to the original closure as this can damage the base material. The user is additionally reminded that the EXOSKIN-S2 is an essential item of PPE that must be correctly maintained to assure its continued maximum protection capability in a threat environment.

The lateral throat closure tab should be approximately horizontal to fully align the hook and loop components; to open this tab it should be pulled from the tabs leading edge horizontally across the throat line of the suit. This allows the hook & loop fixtures to open correctly without inputting stress to the suit structure.

The storm-flap closure over the jacket frontal zip has hook & loop fastenings from hem to throat; this storm flap should be opened carefully before any attempt to force the zip open. The vertically positioned bib tab at the throat of the closure is static and should not be used to leverage incorrect opening of the suit.

- Ensure all hook & loop and zip fastenings are closed prior to folding the garment. Visually check the garment for damage such as holing, tears, staining which may affect full protection at next use. Such damage found renders the suit unsuitable for future operational usage and replacement is essential.
- When checks are completed, fold and store the jacket and trousers in accordance with this UI recommendations. Where practical, keep the suit protected from sunlight and external sources of benign environmental contamination.
- Suits designated for laundering should also be presented in the same way, with all zips and closures fastened – but folding is not necessary for this cleaning process. On return from laundering the user should check that the total laundering cycles label in the back neck of the jacket and the waistband of the trouser have been appropriately marked to show the number of launderings undertaken. A further visual check by the user to ensure there is no evident damage to the suit materials or structure should be undertaken. The user should always bear in mind that it is their personal responsibility to ensure the suits physical condition is appropriate for future operational usage.

---

### DISCLAIMER

Before donning the EXOSKIN system, full inspection by the user should be conducted. If any signs of damage, contamination or wear and tear is discovered, the garment must be disposed of in accordance with local SOP's and a new EXOSKIN-S2 should be donned.

## 5.0 DOFFING A CONTAMINATED EXOSKIN-S2

When doffing a contaminated suit the user should refer to their Contamination Control Area (CCA) protocols.

## 6.0 FOLDING THE EXOSKIN-S2 JACKET

- Shake-out to return jacket to normal shape and remove any creases imposed by accessory equipment such as load carriage or body armor.
- If the jacket is damp from wear, allow to air dry for at least 15 minutes.
- Fasten the center front zip & fasten hook & loop tape closures at hood, front and wrist.
- Fold the jacket as shown in the folding diagram below.
- Squeeze jacket to expel as much air as possible.
- Place the jacket into the already opened clear plastic bag and again squeeze any excess air out of the jacket.

Figure 1: Jacket Folding

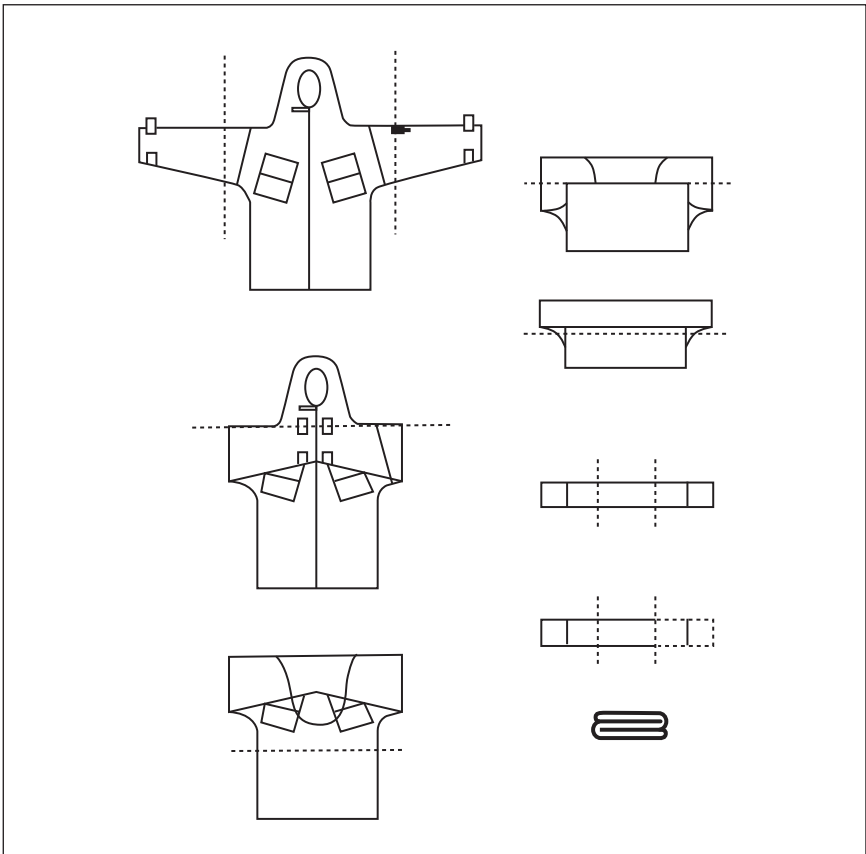

---

## FOLDING THE EXOSKIN-S2 TROUSER

- Shake-out to return the trousers to their normal shape.
- If the trousers are damp from wear, allow them to air dry for at least 15 minutes.
- Lay out the trousers and fasten the front fly zip & fully close all hook & loop fastening tabs at the waist, inner gaiter, and outer leg positions.
- Tuck the braces inside the legs.
- Fold the trousers as shown in the folding diagram below.
- Squeeze trouser to expel as much air as possible.
- Place the trouser into the already opened clear plastic bag along with the folded jacket, squeeze out any excess air and firmly close the grip-seal.

Figure 2: Trouser Folding

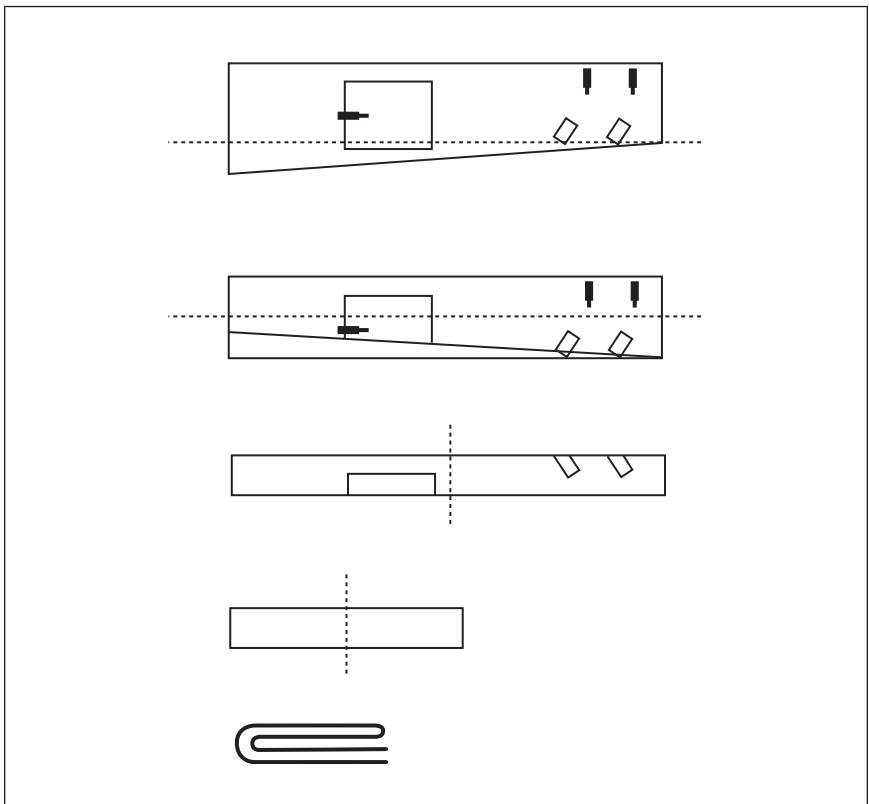

## 7.0 LIFE CYCLE OF THE EXOSKIN-S2

The expected life of the EXOSKIN-S2 is wholly dependent on the environment in which it is deployed. This section is aimed at providing guidelines for SOPs to understand the expected usability of the EXOSKIN-S2 as it relates to the intended use and the prevailing environmental conditions.

The stated life cycle of the EXOSKIN-S2 takes account of its potential usage in a non-chemical warfare contaminated environment and then its subsequent usage in a CWA challenge environment.

The range of atmospheric contaminants include but are not limited to:

- Dust
- Pollen
- Diesel fume particulates
- Smoke
- Solvent fumes

---

### BENIGN CONDITIONS

Benign conditions are environments where the challenge matter to the EXOSKIN-S2 is not life-threatening but nevertheless carrying airborne pollutants described above.

---

### THREATENED ENVIRONMENT

A threatened environment where there is the potential for CWA challenge to occur but where the suit can be worn in a stand-by state.

In this context, Avon Protection CBRN defines 'Non-Toxic Environments' as those that are not exposed to chemical warfare agents, but which are exposed to a range of normal atmospheric contaminants, e.g., dust, pollen, diesel fumes, certain airborne POL's (smoke, solvent fumes for example). It will be a decision dictated by local SOP's as to whether such contamination is 'lightly benign' or 'heavily benign' in character and concentration; for example, a user in constant close contact with running diesel engines may be considered to be in a 'heavily benign' area whilst another in an open environment could be considered to be in a 'lightly benign' area.

If the CBRN risk is threatened but not actual, the EXOSKIN-S2 can be worn in a stand-by mode (refer to user specific local SOP's) where it is only exposed to lightly benign atmospheric contamination.

Under these conditions, the garment is usable for a cumulative period of 40 days if the user is not regularly working in areas of heavily benign contamination. In more lightly benign atmospheric conditions, the EXOSKIN-S2 consumes its cumulative 40 days of active use within a period of 6 months. This will be a choice dictated by local SOP's and the operating environment.

This recommended 40-day period can be consumed in one singular and continuous wearing or it can be donned and doffed repeatedly over a 6-month period, on the condition the wearer maintains the appropriate logging of these timelines and follows the re-packing procedures outlined above. (Section 6.0).

After the 6-month period has elapsed, the EXOSKIN-S2 should be automatically discarded/replaced, the suit should be disposed of in accordance with local SOPs/guidelines, irrespective of whether the 40 days cumulative usage has been consumed.

---

## EMERGENCY ENVIRONMENT

A critical environment where a spontaneous and immediate challenge by CWA is occurring and full donning of the EXOSKIN-S2 is necessary.

In this context, Avon Protection CBRN defines a 'Toxic Contaminated Environment' as one that is challenged by chemical warfare agents, e.g., Mustard gas, Sarin, Soman, VX, etc., which are primarily airborne in character but inclusive of those that transform into surface depositions. In this type of environment, the EXOSKIN-S2 will have a cumulative 24-hour protection capability, after which the user should ensure safe-doffing in accordance with Section 5.0 and then proceed with the donning of a new suit if the threat continues.

Where the EXOSKIN-S2 has been exposed to CWA contamination it should be safely doffed and replaced with a new EXOSKIN-S2, i.e., if the EXOSKIN-S2 is only exposed to CWA for <24 hours it should not be re-packed for subsequent use but removed through safe doffing SOP's and disposed of appropriately in accordance with Section 5.0.

- To unpack a new EXOSKIN-S2, remove the garment pouch from the clear plastic grip seal bag, tear from the notched long edge across the breadth of the garment pouch.
- Extract the garment elements – jacket and trouser – and 'shake them out' to restore shape and to facilitate ease of donning.
- Discard the garment pouch but retain the clear outer bag with the grip-seal for future use.
- Time permitting – but without jeopardizing personal safety in an emergency – inspect both jacket and trouser for any evident functional defects and then don in the manner referenced in Section 3.0.
- If the EXOSKIN-S2 is exposed to any chemical warfare agent during operations, at a point where the wearer can safely withdraw from the contaminated area, the EXOSKIN-S2 should be doffed using the safe-undressing procedure referenced in Section 5.0.
- If the EXOSKIN-S2 is used in a contaminated environment as outlined above, the PPE should not be repacked and reused under any circumstances.
- The EXOSKIN-S2 must be decommissioned and disposed of in accordance with local SOP's.

---

## TIME-FRAMES WHEN DEPLOYED

The EXOSKIN-S2's life cycle commences from when the garment is removed from the garment pouch. This cycle is 40 days of cumulative usage in a non-chemical warfare agent contaminated environment within a six-month overall time bloc.

The 40 days cumulative time must be consumed within a six-month overall period. The activated carbon comprehensively absorbs all airborne contaminants of any description (see Section 7.0) so it is important to note that even in normal atmospheric conditions it will be absorbing airborne material that is not necessarily life threatening but which is progressively consuming the time capacity of the EXOSKIN-S2 over its life-cycle. The table below shows the operational time-frames based on certain conditions.

**Table 1:**

<b>Operational Conditions</b>	<b>Prevailing Environment</b>	<b>Shelf-life and Usage Assumptions</b>
Baseline Conditions	In original packaging in accordance with recommended storage guidelines	10 year shelf-life
Non-Toxic Non-Hazardous	No exposure to chemical warfare agent's; but exposure to:  Atmospheric contaminants as per Section 7.0	The suit is usable for a cumulative period of at least 40 days if the user is not regularly working in areas of extremely dense atmospheric contamination
Toxic- Contaminated	Emergency donning in a chemical warfare environment	24 hours protection capability over and above the 40-day life cycle, i.e. a total life cycle of 41 cumulative days  The suit should not be re-packed and re-used under any circumstances  The suit must be decommissioned and disposed of in accordance with SOP's

## 8.0 WARNINGS & CAUTIONS UNDER NORMAL OPERATING CONDITIONS

The user must read and understand these warnings and cautions. Failure to follow these warnings and cautions could result in serious injury or death.



Exertion in hot conditions may result in heat exhaustion. Symptoms include: clammy skin, dizziness, headache, muscle cramps, extreme thirst, excessive sweating, dehydration, fainting, nausea, vomiting, weakness or decreased urine output. If the user exhibits any of the above they must be escorted to a safe area, remove the EXOSKIN-S2 in a known clean environment and seek urgent medical attention.



Exertion in cold conditions may result in cold exhaustion. Symptoms include: fatigue, dry skin, feeling absent minded, depression, constipation, sore throat, cough, congestion or running nose, aches, low-grade fever/chills. If the user exhibits any of the above they must be escorted to a safe area, remove the EXOSKIN-S2 in a known clean environment and seek urgent medical attention.



DO NOT use the EXOSKIN-S2 if it is damaged, dirty or out of date, the EXOSKIN-S2 will not provide the user with the necessary protection when required. Always follow the cleaning instructions referenced in section 9.0.



The user should wear this PPE only if they have been appropriately trained in hazardous environment protection against airborne contaminants and have knowledge of the correct selection, fit, use, care and limitations of protective clothing and equipment.



This EXOSKIN-S2 system provides limited protection against heat and flame.

Minimize exposure to heat/flame.



This EXOSKIN-S2 system has a limited operational, safe life. The user must inspect the system regularly and replace the garment when appropriate according to the information provided in this UI.

## 9.0 CLEANING INSTRUCTIONS

The user can launder the EXOSKIN-S2 to remove dirt, perspiration, soiling, etc. It can be laundered according to the recommendations in this UI up to 10 times within the 40-day exposure life-cycle. A laundering log is positioned within the garment on the labels in both jacket and trouser to indicate used and remaining laundering cycles. A lightly soiled EXOSKIN-S2 can be wiped/sponged down with clean water only. Ensure not to soak the garment material.



Record the number of laundering and wearing cycles on the garment itself, by placing an "X" over the appropriate number. Mark with an indelible laundry marker only.



Before commencing the wash cycle on the Avon Protection EXOSKIN-S2, the jacket and trousers should be pre-prepared by ensuring all zips and hook & loop tab fastenings are closed to prevent any possible snagging of the material during the wash cycle.



Washing machine must not be used for any other clothing other than EXOSKIN-S2.







Avon Protection recommends the use of a detergent that is a non-ionic surfactant without added fabric softener to launder EXOSKIN-S2. Not more than 3 drops per load.

**NOTE:** After a washing cycle, the outer clothing layer of the EXOSKIN-S2 system must be carefully ironed only when dry on a non-steam setting at a maximum temperature of 110°C (230°F) to re-activate the oil and water-resistant properties of the garment.

## EXOSKIN-S2 LAUNDERING INSTRUCTIONS

Table 2:

	Washing	40°C gentle wash cycle; use only half full drum. Domestic washing is not recommended - preference should be given to generic laundering facilities under the control of the end-user authority
	Detergent	Use only non-biological detergents and do not use any fabric softeners
	Rinsing	Rinse thoroughly (twice) after washing
	Spin Dry	Spin dry for 20 seconds, after wash and rinse cycle completion
	Chlorination	Do not use chlorine or bleach
	Ironing	Iron on a low heat, maximum of 110°C (230°F), dry only - no steam
	Dry Cleaning	Do not dry clean
	Drying	Tumble dry on low heat 50-55°C (122- 131°F)

## 10.0 SYSTEM OPTIONS & CONFIGURATIONS

The EXOSKIN-S2 is of unisex design and as such is available in the following nominal sizes, based on the guidelines within BS EN ISO 13688:2013. The table below shows all the sizes available.

**Table 3:**

Size	Height		Chest		Waist		Inside Leg	
	cm	in	cm	in	cm	in	cm	in
Small/Short	165-173	65-68	84-92	33-36	80-88	31-34	74	29
Medium/Short			92-100	36-39	88-96	34-37		
Large/Short			100-108	39-42	96-104	37-41		
X-Large/Short			108-116	42-46	104-112	41-44		
2XL/Short			116-124	46-49	112-120	44-47		
3XL/Short			124-132	49-52	120-128	47-50		
Small/Regular	173-180	68-71	84-92	33-36	80-88	31-34	79	31
Medium/Regular			92-100	36-39	88-96	34-37		
Large/Regular			100-108	39-42	96-104	37-41		
X-Large/Regular			108-116	42-46	104-112	41-44		
2XL/Regular			116-124	46-49	112-120	44-47		
3XL/Regular			124-132	49-52	120-128	47-50		
Small/Tall	180-188	71-74	84-92	33-36	80-88	31-34	84	33
Medium/Tall			92-100	36-39	88-96	34-37		
Large/Tall			100-108	39-42	96-104	37-41		
X-Large/Tall			108-116	42-46	104-112	41-44		
2XL/Tall			116-124	46-49	112-120	44-47		
3XL/Tall			124-132	49-52	120-128	47-50		

## SYSTEM OPTIONS & CONFIGURATIONS (CONTINUED)

### SPECIFIC CBRN ANCILLARIES USED WITH THE EXOSKIN-S2 SUIT

Respiratory Protection:	Avon Protection FM50, C50, FM53, FM54, GSR
Foot Protection:	EXOSKIN-B1 CBRN overboots
Hand Protection:	EXOSKIN-G1 CBRN gloves and liners



This UI has been written to only reflect the products listed above. The determined level of protection afforded by the EXOSKIN-S2 system is only achieved when the identified products are used collectively. The use of any alternative products may impact the effectiveness of the EXOSKIN-S2 system and may lead to serious injury or death of personnel.

## 11.0 IDENTIFICATION & LABELING



Labels: There are two important safety and information labels. The danger and cleaning label provides critical safety information and directs the user to read and understand this UI. The label also explains the product information and washing instructions. The garment and bag labels are detailed to show the information provided.

Figure 3:



Figure 4:

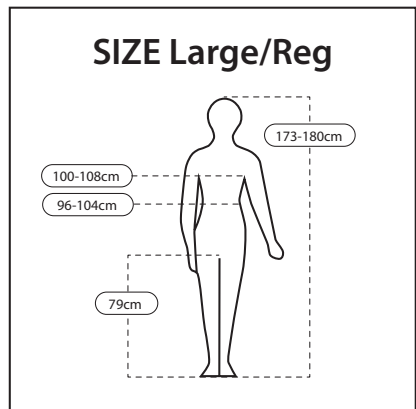

## IDENTIFICATION & LABELING (CONTINUED)

Figure 5:

# AVON

## PROTECTION

### Avon 1 CBRN Hoodie - JKT149

 Delicate wash

 Do not bleach

 Low tumble dry

 Cool iron

Please read user information sheet



Name: \_\_\_\_\_

Site: \_\_\_\_\_ Rank: \_\_\_\_\_

Location: \_\_\_\_\_ Serial No: \_\_\_\_\_

1	2	3	4	5
6	7	8	9	10

To ensure the CBRN protection, this garment should only be laundered the maximum of 10 times. Please mark box after each laundering.

  
771309530002

**DO NOT REMOVE THIS LABEL**

### LABEL LOCATION

- Jacket label positioned internally on the back lining.
- Trousler label internally on the back lining.

## 12.0 STORAGE

Garments that are not for immediate deployment should remain in their original packaging and stored in a personal locker or holdall at ambient temperature, away from direct and UV light sources and moisture that may cause damage to the garment.

Before individual distribution, the EXOSKIN-S2 packaging must be stored:

- In a clean, dust free environment.
- Within a temperature range of -30°C to +55°C (-22°F to 131°F).
- Maximum average relative humidity of <85%.
- Away from direct sunlight.
- In the original packaging.

## 13.0 PACKAGING

---

### GARMENT BAGS

The EXOSKIN-S2 jacket and trousers are each provided in two packaging layers. The inner garment pouch and the outer grip seal bag. The purpose of these packages is to ensure that the activated carbon used within the suit is kept as uncontaminated as possible pre-usage and to limit any external moisture or UV light contamination.

The outer grip sealed bag provides a package to safely store the suit in once the sealed bag has been opened.

The garment pouch is vacuum packed, which compresses the garment into a suitable carry-size for the user. The garment can be removed from the garment pouch by tearing the edge at the 'notch'. The operational life cycle of the suit commences 40 days of cumulative usage within a six-month period from date the sealed bag is opened. The garment pouch can be discarded once opened. The grip sealed bag should be retained to allow the suit to be stored again if needed.

Occasionally, the garment pouch may lose vacuum; the suit within remains safe to use provided the outer grip seal bag remains firmly closed. The outer grip seal clear plastic bag adds an additional assurance against risk posed to the functionality of the suit. The minimum life cycle of the suit will not be affected provided it is contained in at least one of the packages and stored in accordance with Section 12 - Storage.

---

### UNSEALED JACKET AND/OR TROUSER BAGS

Bags that are unsealed and not within a closed outer grip-seal bag are potentially exposed to atmospheric contamination. This accidental exposure is unlikely to have been logged. As a result, any such suit should be regarded as 'unsuitable' to wear in an operational environment.

If there is any doubt with regards to the operational suitability of the garment it is to be removed from service and disposed of in accordance with local guidelines/SOPs.

---

### GRIP SEAL BAG

Both jacket and trouser bags are supplied inside a clear, grip-seal plastic bag. This bag should be retained for future use and storage of the suit in accordance with Section 12.

## 14.0 SHELF-LIFE

### IMPACT OF PACKAGING

The below table outlines the shelf-life parameters of the garments given foreseeable impact to packaging and storage conditions.

Table 4:

	Configuration	Garment Pouch	Grip Deal Bag	Shelf-Life
A	In original packaging	Sealed	Sealed	Maximum 10-year shelf-life
B	In original packaging	Unsealed	Sealed	The suit remains safe and usable whilst the grip-seal of the outer clear plastic bag is fully closed and will have a maximum shelf-life of 10-years
C	In original packaging	Unsealed	Unsealed	It is suggested to follow the actions outlined in Section 13 depending on the potential risk of atmospheric contaminants interaction with the garment itself
D	Not in original packaging	Unsealed	Unsealed	If the history of the garment is unknown. The suit should be assumed unacceptable for deployment and discarded accordingly

## 15.0 ADDITIONAL INFORMATION

---

### FUNCTIONAL GARMENT DEFECTS

- If at any point in the EXOSKIN-S2's life cycle a defect that could affect the integrity and safety of the suit is observed, then it must be replaced.
- Any functional defects, e.g., a sticking zip, material damage, contamination etc., will require the garment to be replaced.
- The garments labeling identifies its unique serial number. This number cross-references with the bar coding of the original product delivery batch which enables identification and traceability of the product for any remedial actions to be undertaken if required.

---

### PACKAGING

- If the risk of atmospheric contaminant interaction with the garment is considered high, the end-user should take the safeguarding actions outlined in Section 13.0.

## 16.0 CHECKLIST

- Before using the EXOSKIN-S2 ensure that the user is fully aware of the environment they are either immediately threatened with or potentially threatened by.
- If there is time at the onset of an emergency donning, check the EXOSKIN-S2 for any clear defects. Thorough checking of the EXOSKIN-S2 prior to donning and after doffing will ensure the suit remains in a state of serviceability and readiness for next use.
- Maintain the EXOSKIN-S2 in line with these recommendations to assure effective and safe use when required.



It is essential the 40 day cycle of the EXOSKIN-S2 is rigorously documented within its 6 month finite life span





**The Americas**

t: +1 888 286 6440

e: [customerservice@avon-protection.com](mailto:customerservice@avon-protection.com)

**Europe, Middle East, Asia, Africa & Australasia**

t: +44 (0) 1225 896705

e: [protection@avon-protection.com](mailto:protection@avon-protection.com)

[avon-protection.com/contact](https://avon-protection.com/contact)